

Carrera White:51

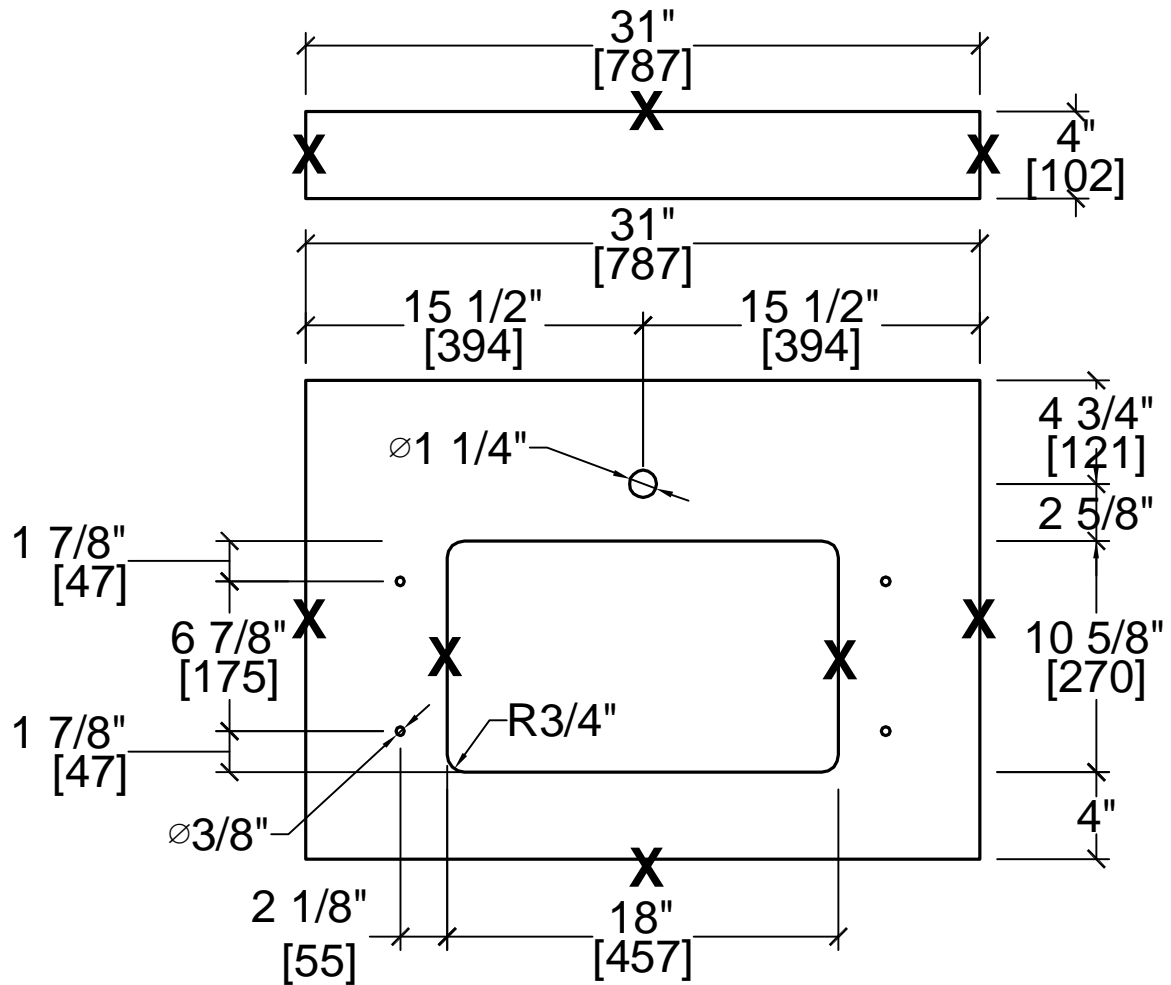

Williams Kitchen & Bath

Client:

Project:

NO.

1

Drawing Title: Vanity Top

Material & Quantity:

Carrera White

Thickness:

Top: 3cm
Splash: 2cm

Edge Profiles:

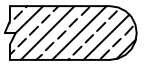
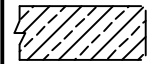

X
Eased & Polished

B
Full Bullnose

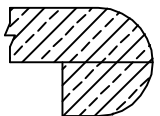
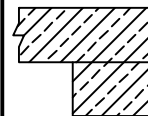

DX
Double Eased P.

DB
Double Bullnose

Drawing Date: 16-04-01

Drafter: Eric

Reviewed by: Nicole

Rev.no:

Rev.date:

Carrera White:51

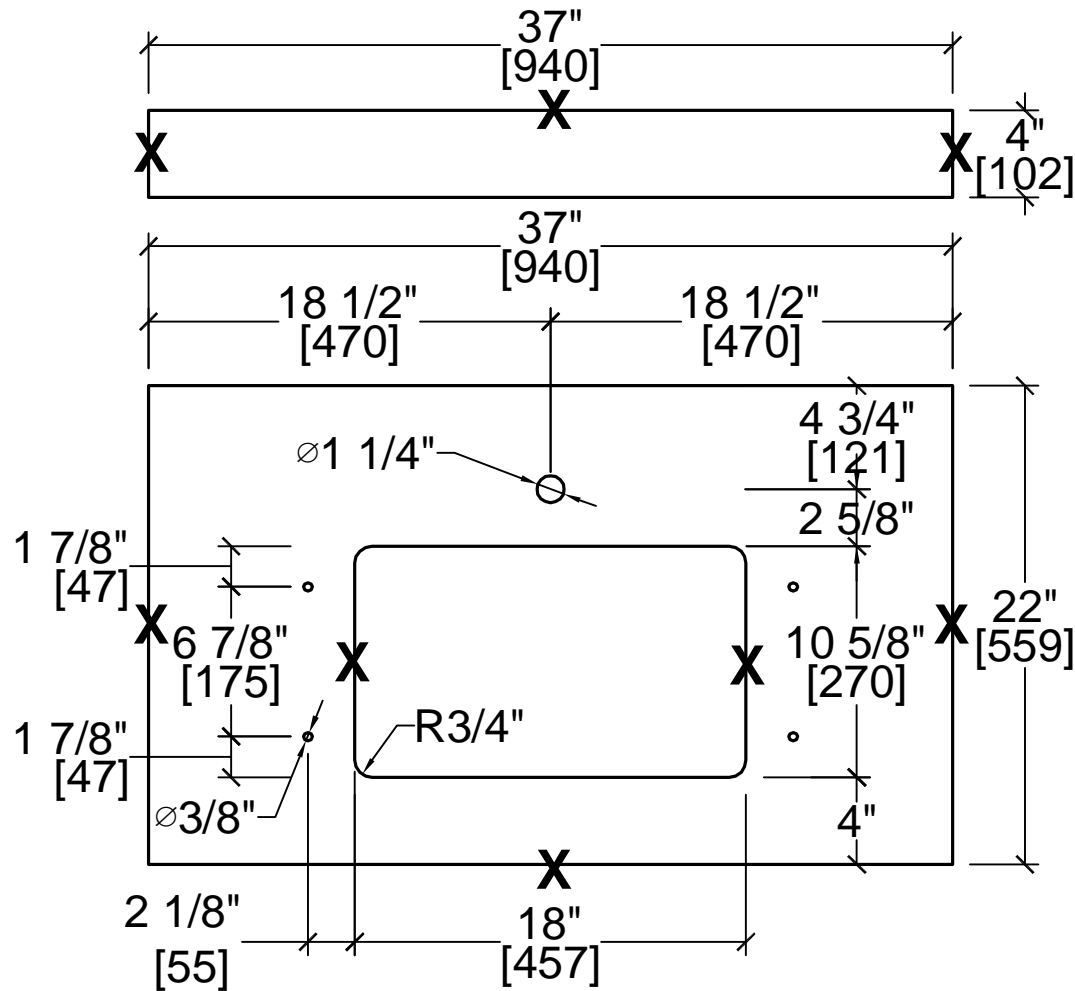

Williams Kitchen & Bath

Client:

Project:

NO.

2

Drawing Title: Vanity Top

Material & Quantity:

Carrera White

Thickness:

Top: 3cm
Splash: 2cm

Edge Profiles:

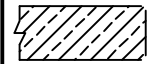

X
Eased & Polished

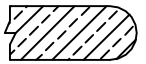

B
Full Bullnose

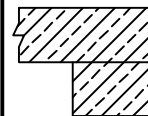

DX
Double Eased P.

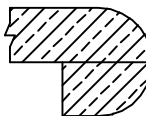

DB
Double Bullnose

Drawing Date: 16-04-01

Drafter: Eric

Reviewed by: Nicole

Rev.no:

Rev.date:

Carrera White:17

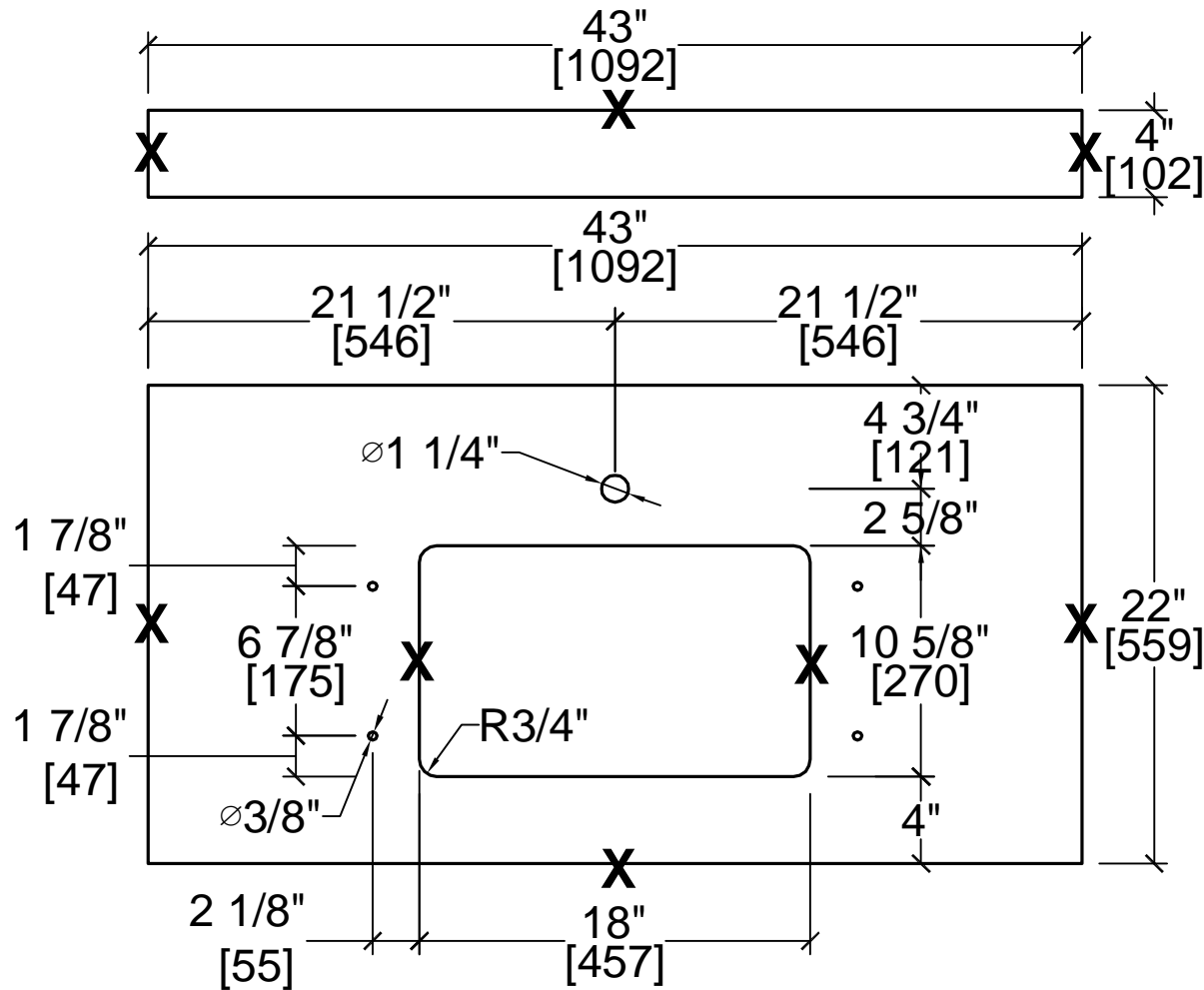

Williams Kitchen & Bath

Client:

Project:

NO.

3

Drawing Title: Vanity Top

Material & Quantity:

Carrera White

Thickness:

Top: 3cm
Splash: 2cm

Edge Profiles:

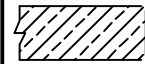

X
Eased & Polished

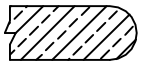

B
Full Bullnose

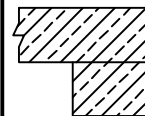

DX
Double Eased P.

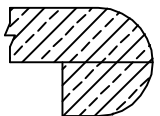

DB
Double Bullnose

Drawing Date: 16-04-01

Drafter: Eric

Reviewed by: Nicole

Rev.no:

Rev.date:

Carrera White:51

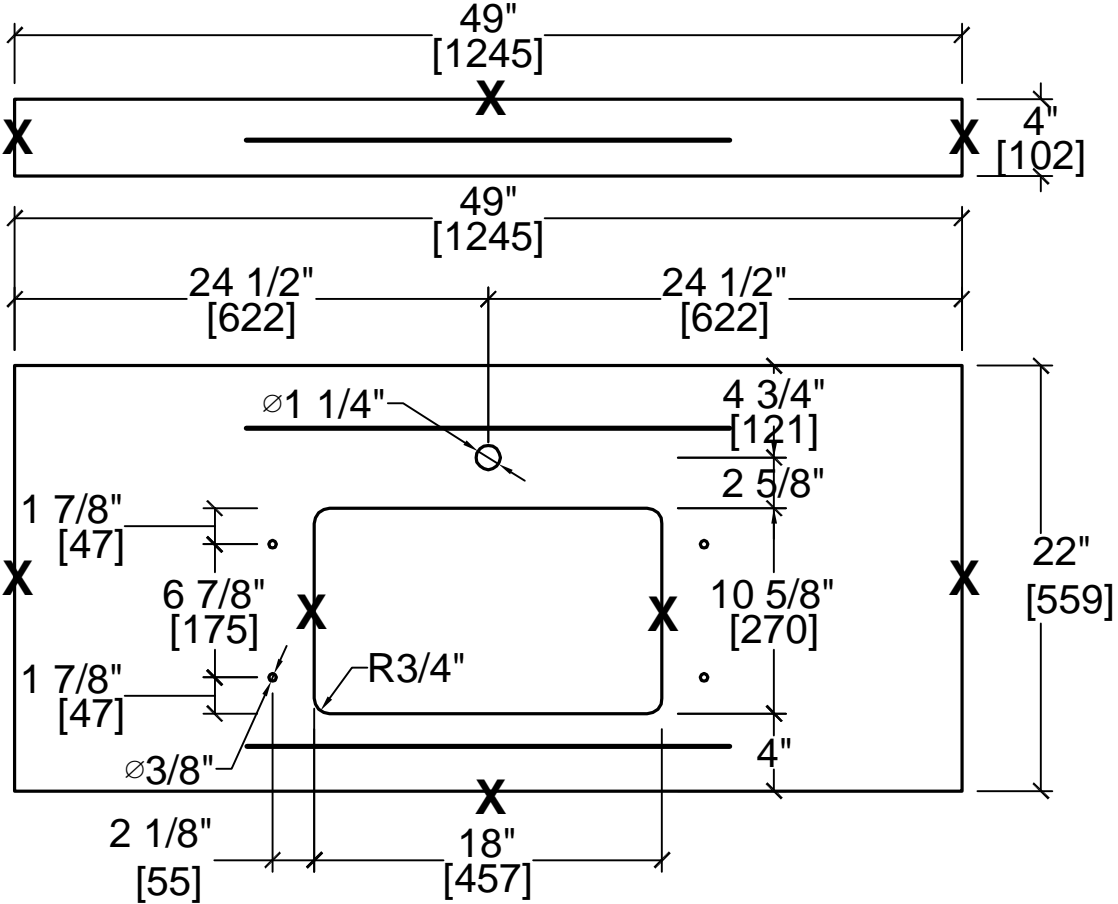

Williams Kitchen & Bath

Client:

Project:

NO.

4

Drawing Title:

Vanity Top

Material & Quantity:

Carrera White

Thickness:

Top: 3cm
Splash: 2cm

Edge Profiles:

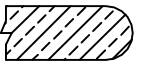
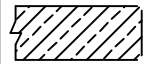

X
Eased & Polished

B
Full Bullnose

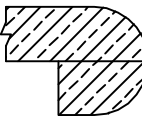
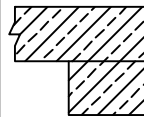

DX
Double Eased P.

DB
Double Bullnose

Drawing Date:

16-04-01

Drafter:

Eric

Reviewed by:

Nicole

Rev.no:

Rev.date:

Carrera White:18

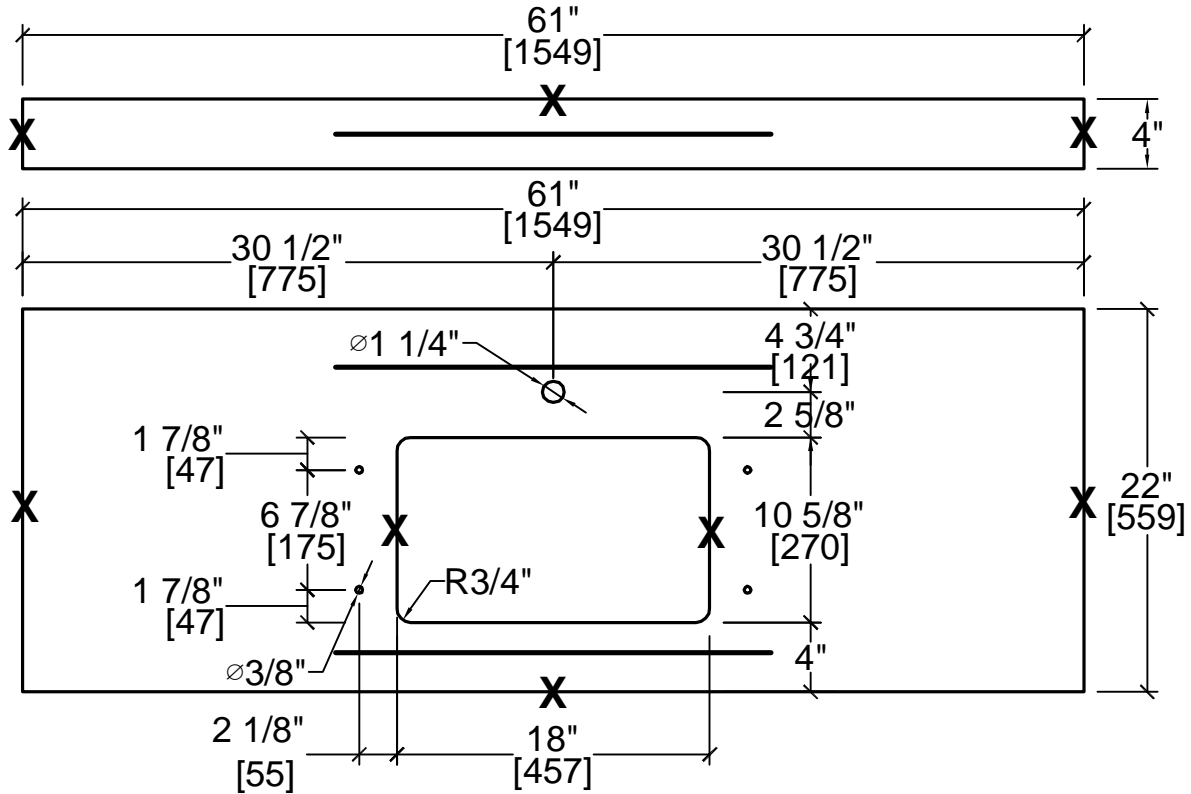

Williams Kitchen & Bath

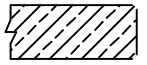
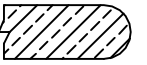
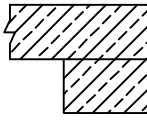
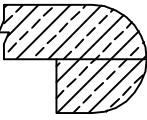
Client:	
Project:	
NO.	5
Drawing Title:	Vanity Top
Material & Quantity:	
Carrera White	
Thickness:	Top: 3cm Splash: 2cm
Edge Profiles:	
	
X Eased & Polished	B Full Bullnose
	
DX Double Eased P.	DB Double Bullnose
Drawing Date:	16-04-01
Drafter:	Eric
Reviewed by:	Nicole
Rev.no:	
Rev.date:	

Carrera White:18

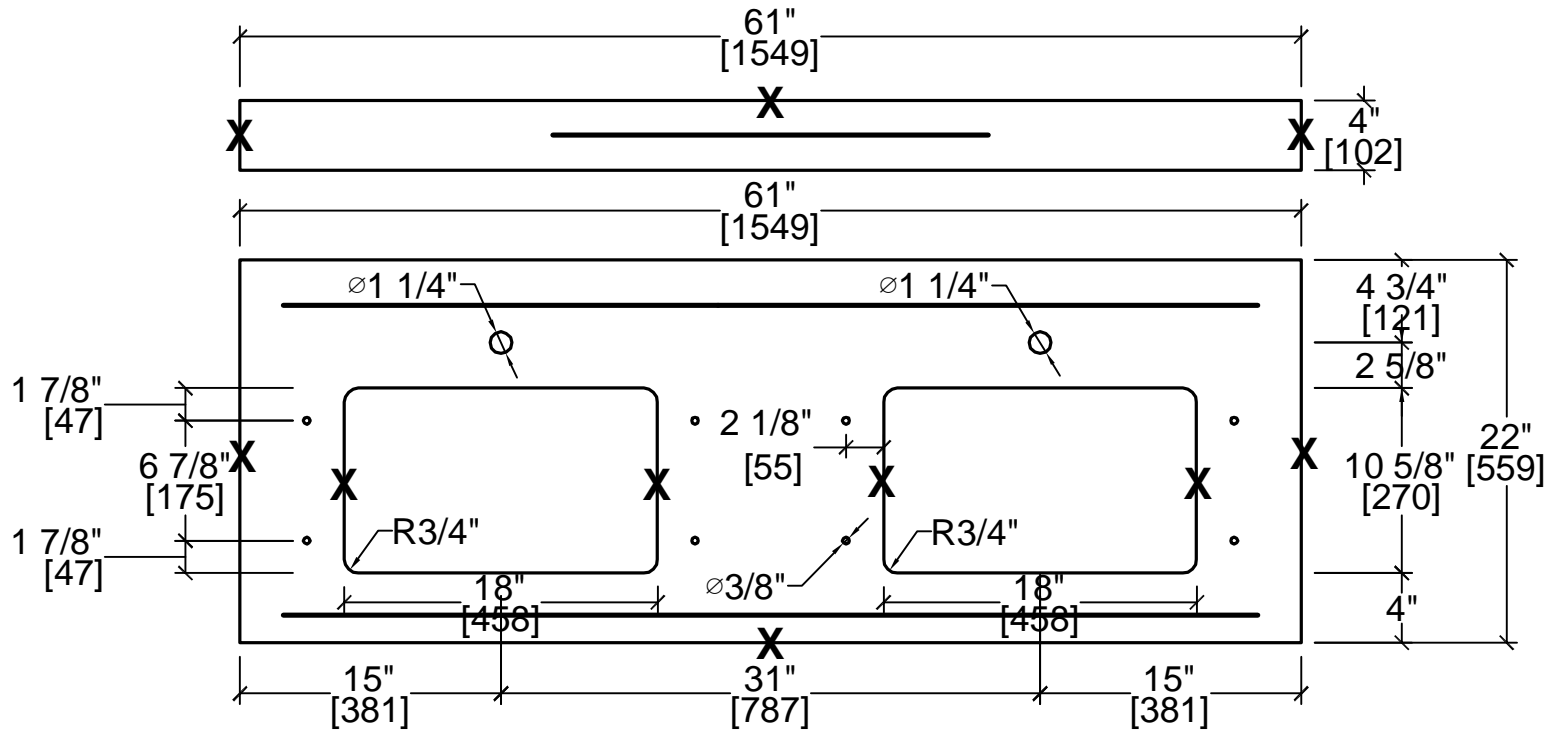

Williams Kitchen & Bath

Client:

Project:

NO.

6

Drawing Title:

Vanity Top

Material & Quantity:

Carrera White

Thickness:

Top: 3cm
Splash: 2cm

Edge Profiles:

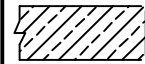

X
Eased & Polished

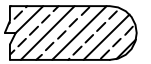

B
Full Bullnose

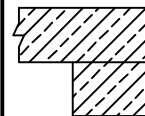

DX
Double Eased P.

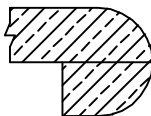

DB
Double Bullnose

Drawing Date:

16-04-01

Drafter:

Eric

Reviewed by:

Nicole

Rev.no:

Rev.date:

Carrera White:24

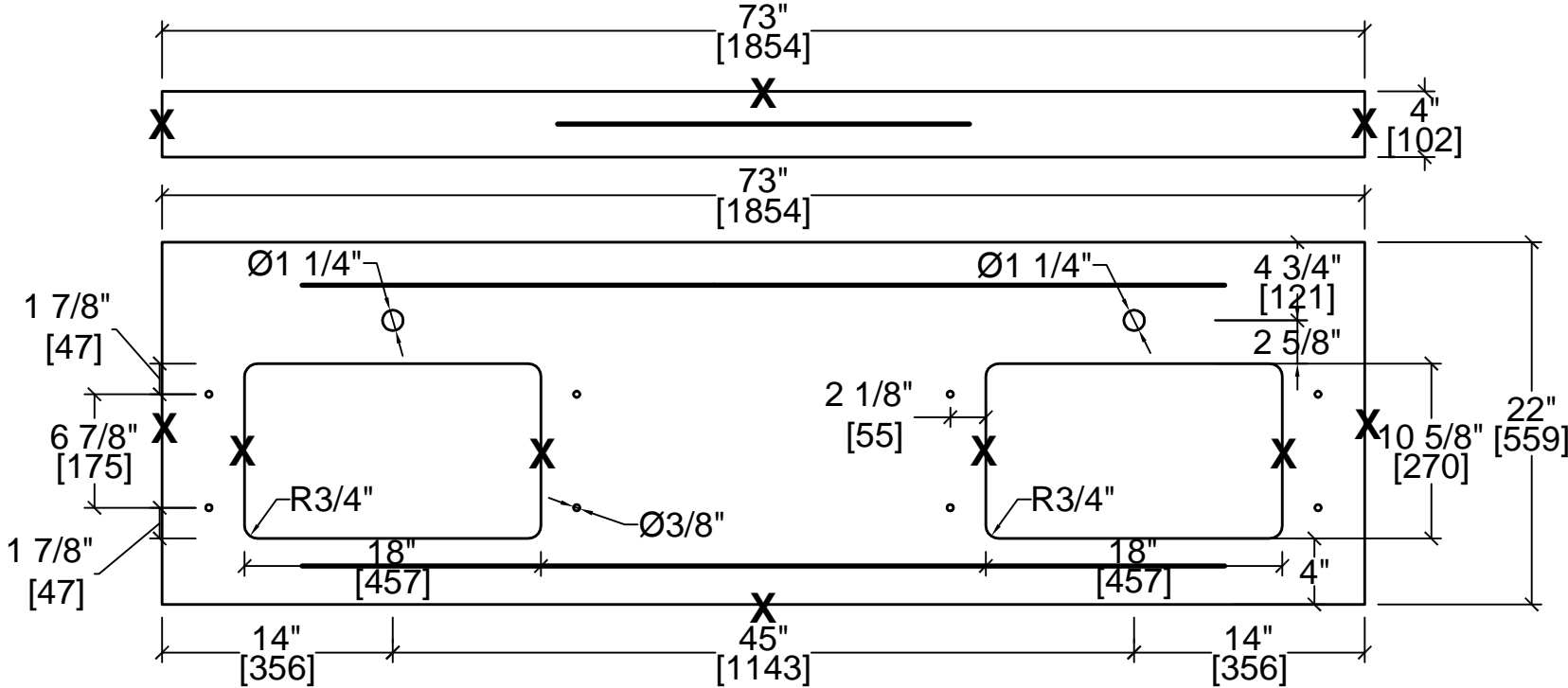

Williams Kitchen & Bath

Client:

Project:

NO.

7

Drawing Title:

Vanity Top

Material & Quantity:

Carrera White

Thickness:

Top: 3cm
Splash: 2cm

Edge Profiles:

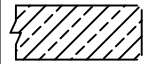

X
Eased & Polished

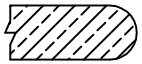

B
Full Bullnose

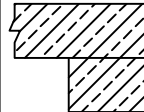

DX
Double Eased P.

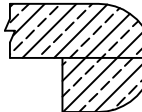

DB
Double Bullnose

Drawing Date:

16-04-01

Drafter:

Eric

Reviewed by:

Nicole

Rev.no:

Rev.date:

***Williams
Kitchen & Bath***

Carrera White:100

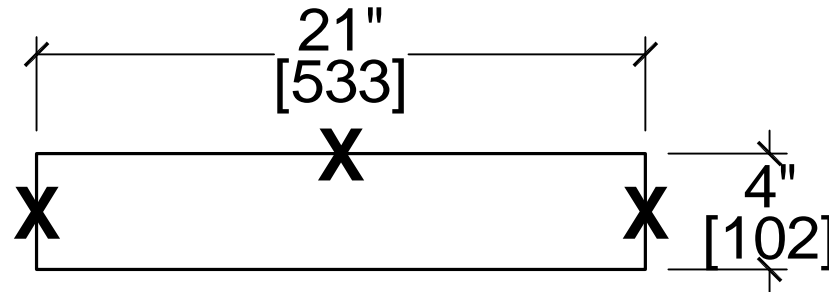

Client:

Project:

NO.

8

Drawing Title:

Vanity Top

Material & Quantity:

Carrera White

Thickness:

Top: 3cm
Splash: 2cm

Edge Profiles:

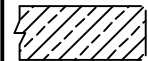

X

Eased & Polished

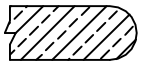

B

Full Bullnose

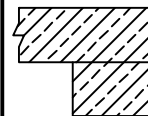

DX

Double Eased P.

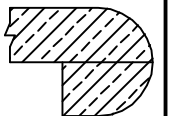

DB

Double Bullnose

Drawing Date:

16-04-01

Drafter:

Eric

Reviewed by:

Nicole

Rev.no:

Rev.date: